

Dell Networking W-IAP110 Series Instant Access Point

Installation Guide

The Dell Networking W-IAP110 Series (W-IAP114 and W-IAP115) wireless Instant Access Point (IAP) supports the IEEE 802.11n standard for high-performance WLAN. It uses MIMO (Multiple-in, Multiple-out) technology and other high-throughput mode techniques to deliver high-performance, 802.11n 2.4 GHz and 5 GHz functionality while simultaneously supporting existing 802.11a/b/g wireless services. The W-IAP110 Series Instant access point works only in conjunction with a virtual controller.

The Dell W-IAP110 Series Instant access point provides the following capabilities:

- Wireless transceiver
- Protocol-independent networking functionality
- IEEE 802.11a/b/g/n operation as a wireless access point
- IEEE 802.11a/b/g/n operation as a wireless air monitor
- Compatibility with IEEE 802.3at PoE+ and 802.3af PoE

Note: The W-IAP110 Series requires Dell Instant 4.0 or later.

Package Contents

- W-IAP114 or W-IAP115 Instant Access Point
- 9/16" and 15/16" Ceiling Rail Adapters
- Quick Start Guide
- Installation Guide (this document)

Note: Inform your supplier if there are any incorrect, missing, or damaged parts. If possible, retain the carton, including the original packing materials. Use these materials to repack and return the unit to the supplier if needed.

W-IAP110 Series Hardware Overview

Figure 1 W-IAP110 Series LEDs

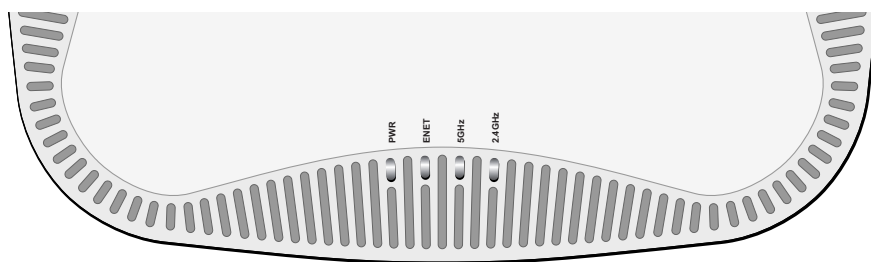

LEDs

The W-IAP110 Series Instant access point is equipped with four LEDs that indicate the status of the various components of the AP.

- PWR: Indicates whether or not the W-IAP110 Series is powered-on
- ENET: Indicates the status of the W-IAP110 Series' Ethernet port
- 5 GHz: Indicates the status of the 802.11a/n radio
- 2.4 GHz: Indicates the status of the 802.11b/g/n radio

LED	Color/State	Meaning
PWR	Off	No power to IAP
	Red	Initial power-up
	Green - Flashing	IAP booting
	Green - Steady	IAP ready
ENET	Off	Ethernet link unavailable
	Yellow - Steady	10/100Mbps Ethernet link established
	Green - Steady	1000Mbps Ethernet link established
	Flashing	Ethernet link activity
5 GHz	Off	5 GHz radio disabled
	Yellow - Steady	5 GHz radio enabled in non-HT WLAN mode
	Green - Steady	5 GHz radio enabled in HT WLAN mode
	Flashing - Green	5 GHz Air or Spectrum Monitor
2.4 GHz	Off	2.4 GHz radio disabled
	Yellow - Steady	2.4 GHz radio enabled in non-HT WLAN mode
	Green - Steady	2.4 GHz radio enabled in HT WLAN mode
	Flashing - Green	2.4 GHz Air or Spectrum Monitor

Figure 2 W-IAP110 Series Side View(W-IAP114 shown)

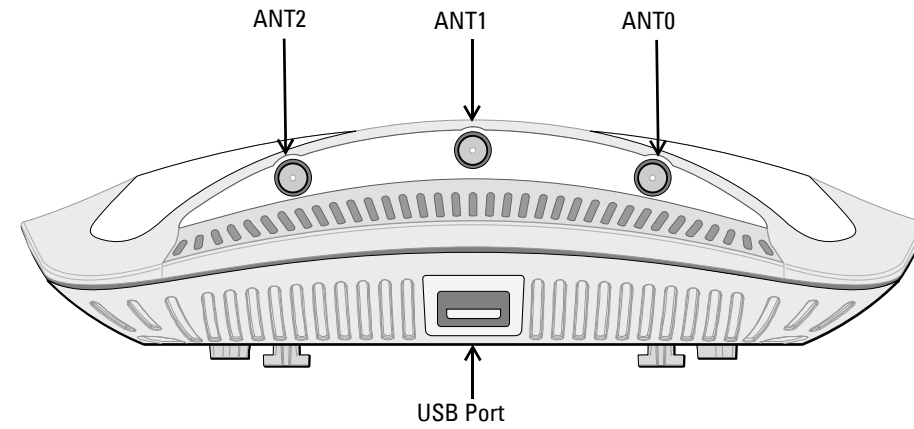

External Antenna Connectors

The W-IAP114 Instant access point is equipped with three external antenna connectors. The connectors are labeled ANT0, ANT1, and ANT2, and correspond to radio chains 0, 1, and 2.

USB Interface

The W-IAP110 Series Instant access point is equipped with a USB interface for connectivity with cellular modems.

Note: The USB interface is disabled when the W-IAP110 Series is powered from 802.3af PoE.

Figure 3 W-IAP110 Series Rear View

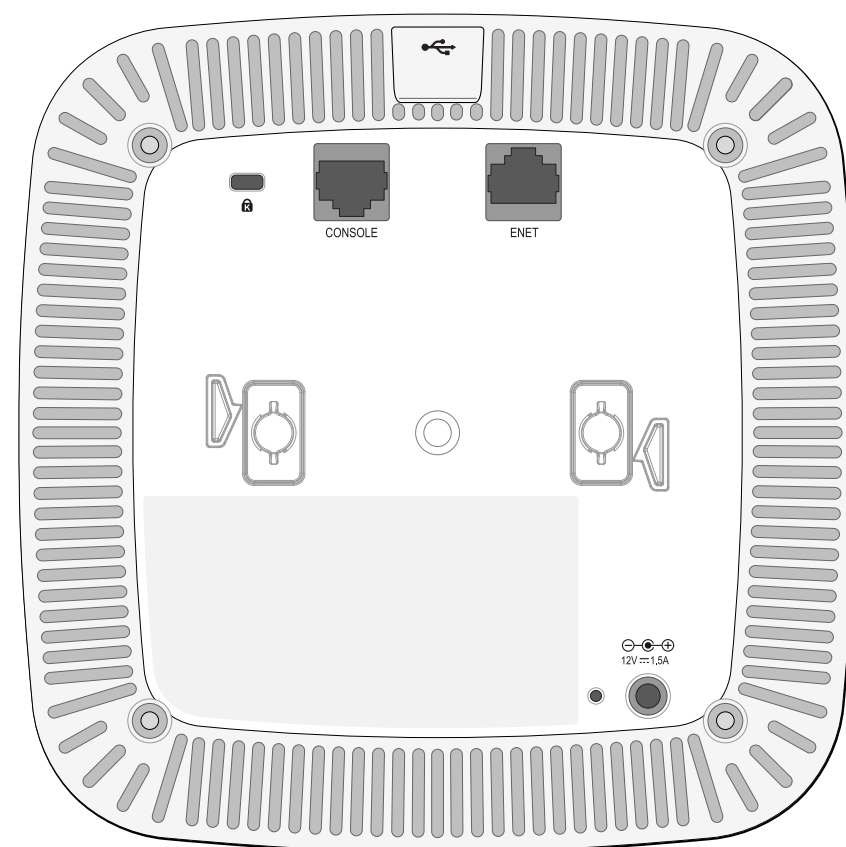

Console Port

The serial console port allows you to connect the W-IAP110 Series Instant access point to a serial terminal or a laptop for direct local management. This port is an RJ-45 female connector with the pinouts described in Figure 4. Connect it directly to a terminal or terminal server using an Ethernet cable.

Figure 4 Serial Port Pin-Out

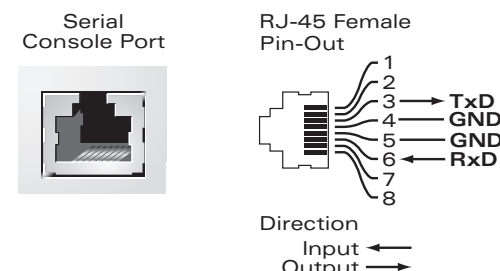

Ethernet Port

The W-IAP110 Series Instant access point is equipped with one 10/100/1000Base-T (RJ-45) auto-sensing, MDI/MDX wired-network connectivity port. The port supports IEEE 802.3af and 802.3at Power over Ethernet (PoE) compliance, accepting 48 VDC (nominal) as a standard defined Powered Device (PD) from a Power Sourcing Equipment (PSE) such as a PoE midspan injector, or network infrastructure that supports PoE. The port has RJ-45 female connector with the pin-outs shown in Figure 5.

Figure 5 Gigabit Ethernet Port Pin-Out

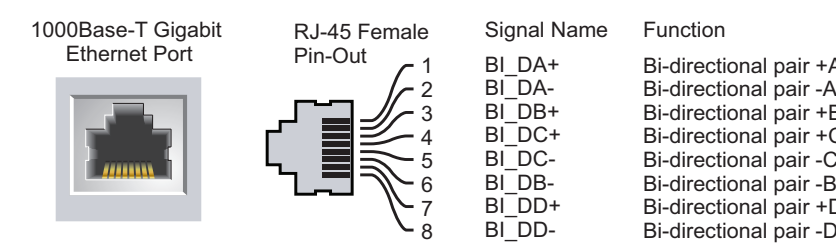

DC Power Socket

If PoE is not available, an optional Dell AP AC-DC adapter kit (sold separately) can be used to power the W-IAP110 Series Instant access point.

Additionally, a locally-sourced AC-to-DC adapter (or any DC source) can be used to power this device, as long as it complies with all applicable local regulatory requirements and the DC interface meets the following specifications:

- 12 VDC (+/- 5%)/18W
- Center-positive 1.7/4.0 mm circular plug, 9.5 mm length

Reset Button

The reset button can be used to return the IAP to factory default settings. To reset the IAP:

1. Power off the IAP.
2. Press and hold the reset button using a small, narrow object, such as a paperclip.
3. Power-on the IAP without releasing the reset button. The power LED will flash within 5 seconds.
4. Release the reset button.

The power LED will flash again within 15 seconds indicating that the reset is completed. The IAP will now continue to boot with the factory default settings.

Before You Begin

Caution: FCC Statement: Improper termination of access points installed in the United States (non-US model Regulatory Domain model/s) will be in violation of the FCC grant of equipment authorization. Any such willful or intentional violation may result in a requirement by the FCC for immediate termination of operation and may be subject to forfeiture (47 CFR 1.80).

Caution: EU Statement: Lower power radio LAN product operating in 2.4 GHz and 5 GHz bands. Please refer to the *Dell Networking W-Series Instant Access Point User Guide* for details on restrictions.

Produit réseau local radio basse puissance operant dans la bande fréquence 2.4 GHz et 5 GHz. Merci de vous référer au *Dell Networking W-Series Instant Access Point User Guide* pour les détails des restrictions.

Low Power FunkLAN Produkt, das im 2.4 GHz und im 5 GHz Band arbeitet. Weitere Informationen bezüglich Einschränkungen finden Sie im *Dell Networking W-Series Instant Access Point User Guide*.

Apparati Radio LAN a bassa Potenza, operanti a 2.4 GHz e 5 GHz. Fare riferimento alla *Dell Networking W-Series Instant Access Point User Guide* per avere informazioni dettagliate sulle restrizioni.

Pre-Installation Checklist

Before installing the W-IAP110 Series Instant access point, ensure that you have the following:

- CAT5e or CAT6 UTP cable of required length
- One of the following power sources:
 - IEEE 802.3at or 802.3af-compliant Power over Ethernet (PoE) source. The POE source can be any midspan power source equipment (PSE) device
 - Dell AP AC-DC adapter kit (sold separately)

Summary of the Setup Process

Successful setup of a W-IAP110 Series Instant access point consists of four tasks, which must be performed in this order:

1. Identify the specific installation location for each IAP.
2. Install each IAP.
3. Verify post-installation connectivity.
4. Configure the virtual controller. Refer to the *Dell Networking W-Series Instant Access Point Quick Start Guide*.

Note: Dell, in compliance with governmental requirements, has designed the W-IAP110 Series access points so that only authorized network administrators can change the settings. For more information about AP configuration, refer to the *Dell Networking W-Series Instant Access Point Quick Start Guide* and *Dell Networking W-Series Instant Access Point User Guide*.

Caution: Access points are radio transmission devices and as such are subject to governmental regulation. Network administrators responsible for the configuration and operation of access points must comply with local broadcast regulations. Specifically, access points must use channel assignments appropriate to the location in which the access point will be used.

Identifying Specific Installation Locations

You can mount the W-IAP110 Series Instant access point on a wall or on the ceiling. Use the AP placement map generated by the Dell RF Plan software application to determine the proper installation location(s). Each location should be as close as possible to the center of the intended coverage area and should be free from obstructions or obvious sources of interference. These RF absorbers/reflectors/interference sources will impact RF propagation and should have been accounted during the planning phase and adjusted in the RF plan.

Identifying Known RF Absorbers/Reflectors/Interference Sources

Identifying known RF absorbers, reflectors, and interference sources while in the field during the installation phase is critical. Make sure that these sources are taken into consideration when you attach an IAP to its fixed location. Examples of sources that degrade RF performance include:

- Cement and brick
- Objects that contain water
- Metal
- Microwave ovens
- Wireless phones and headsets

Installing the IAP

Note: Service to all Dell Networking products should be performed by trained service personnel only.

Using the Ceiling Rail Adapter

The W-IAP110 Series Instant access point ships with two ceiling rail adapters for 9/16" and 15/16" ceiling rails. Additional wall mount adapters and ceiling rail adapters for other rail styles are available as accessory kits.

Caution: Make sure the IAP fits securely on the ceiling tile rail when hanging the device from the ceiling, because poor installation could cause it to fall onto people or equipment.

1. Pull the necessary cables through a prepared hole in the ceiling tile where the IAP will be placed.
2. Place the adapter against the back of the IAP at an angle of approximately 30 degrees to the tabs (see Figure 6).
3. Twist the adapter clockwise until it snaps into place in the tabs (see Figure 6).

Figure 6 Attaching the Ceiling Rail Adapter

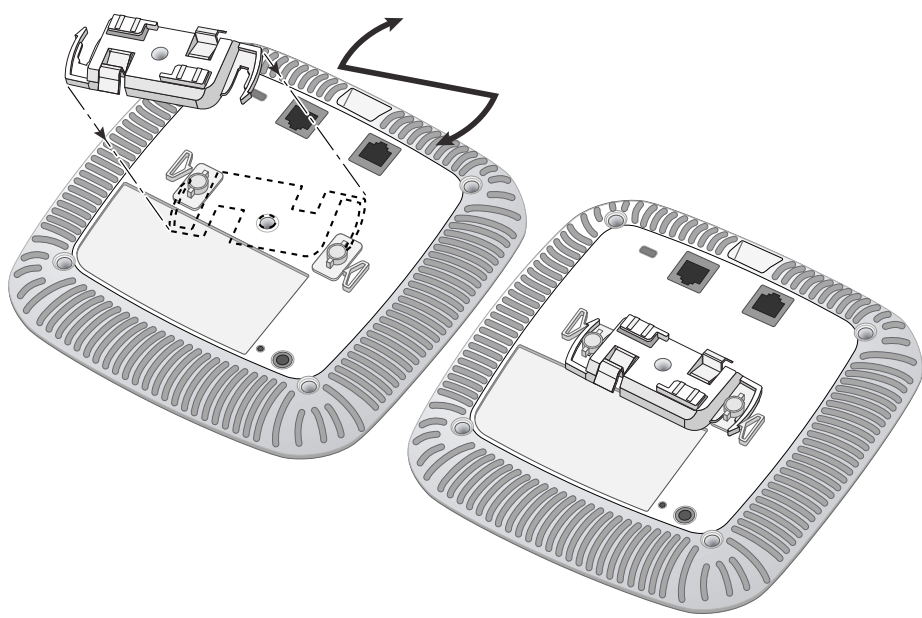

- If necessary, connect the console cable to the console port on the back of the IAP.
- Hold the IAP next to the ceiling tile rail at approximately a 30-degree angle (see [Figure 7](#)). Check if any cable slack is above the ceiling tile.
- Pushing toward the ceiling tile, rotate the AP clockwise until the device clicks into place on the ceiling tile rail.

Figure 7 Mounting the IAP

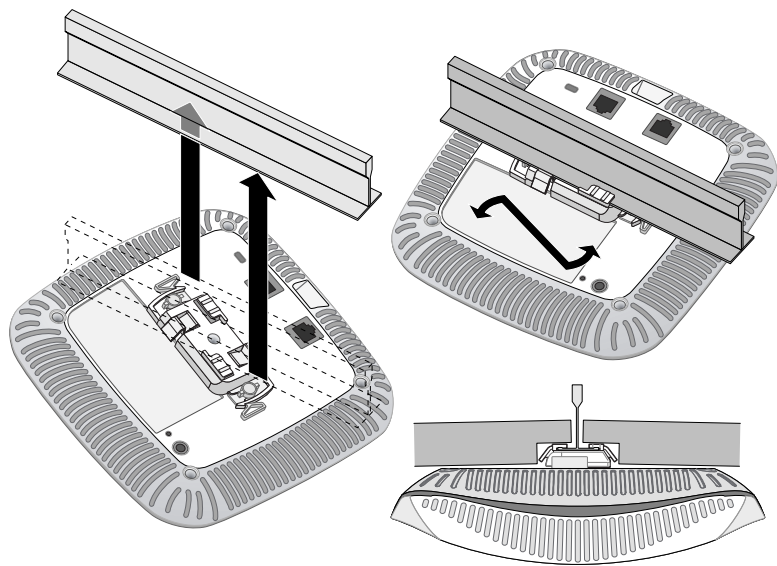

- On the W-IAP114 Instant access point, install the external antennas according to the manufacturer's instructions, and connect the antennas to the antenna interfaces on the IAP.

Connecting Required Cables

Install cables in accordance with all applicable local and national regulations and practices.

Verifying Post-Installation Connectivity

The integrated LEDs on the IAP can be used to verify that the IAP is receiving power and initializing successfully. Refer to the *Dell Networking W-Series Instant Access Point Quick Start Guide* for further details on verifying post-installation network connectivity.

Product Specifications

Electrical

- Ethernet:
 - 1x 10/100/1000Base-T auto-sensing Ethernet RJ-45 Interface
 - MDI/MDX
 - IEEE 802.3 (10Base-T), IEEE 802.3u (100Base-T), IEEE 802.3ab (1000Base-T)
 - Power over Ethernet (IEEE 802.3at and 802.3af compliant), 48V DC (nominal) and 56V DC (maximum)/550mA (see [Figure 5](#) for pin configuration)
- Power:
 - 12 VDC power interface, supports powering through an AC-to-DC power adapter
 - POE support on Ethernet ports: 802.3at-compliant and 802.3af-compliant POE sourcing devices

Note: If a power adapter other than the one provided by Dell is used in the US or Canada, it should be cULus (NRTL) Listed, with an output rated 12 VDC, minimum 1.25A, marked "LPS" or "Class 2," and suitable for plugging into a standard power receptacle in the US and Canada.

For additional specifications on this product, please refer to the product data sheet on [dell.com](#).

Proper Disposal of Dell Equipment

For the most current information about Global Environmental Compliance and Dell products, see [dell.com](#).

Waste of Electrical and Electronic Equipment

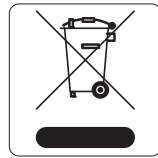

Dell products at end of life are subject to separate collection and treatment in the EU Member States, Norway, and Switzerland and therefore are marked with the symbol shown at the left (crossed-out wheeled bin). The treatment applied at end of life of these products in these countries shall comply with the applicable national laws of countries implementing Directive 2002/96EC on Waste of Electrical and Electronic Equipment (WEEE).

European Union RoHS



Aruba Networks Inc., hereby, being the manufacturer of this product, declares that all CE Marked Dell wireless controller and access points products are manufactured in accordance to the provisional requirements set forth in the RoHS Directive 2011/65/EC.

A copy of the Aruba Declaration of Conformity may be obtained upon request from:

Aruba Networks International Ltd.
Building 1000,
Citygate Mahon
Cork Ireland

Please include the regulatory model number located on the product's regulatory nameplate with the request.

China RoHS



Dell products also comply with China environmental declaration requirements and are labeled with the "EFUP 10" label shown at the left.

部件名称 (Part)	有害物质声明 (Hazardous Materials Declaration)					
	铅 (Pb)	汞 (Hg)	镉 (Cd)	六价铬 (Cr ⁶⁺)	多溴联苯 (PBB)	多溴二苯醚 (PBDE)
电路板 (PCB board)	×	○	○	○	○	○
机械零件 (Mechanical Sub-Assemblies)	×	○	○	○	○	○

○: 表示该有害物质在材料所有材料中的含量均在 SJ/T11363-2006 标准规定的限值要求以下。
Indicates that the concentration of the hazardous substance in all homogeneous materials in the parts is below the relevant threshold of the SJ/T11363-2006 standard.

×: 表示该有害物质至少在该部件的某一构成材料中的含量超过 SJ/T11363-2006 标准规定的限值要求。
Indicates that the concentration of the hazardous substance of at least one of all homogeneous materials in the parts is above the relevant threshold of the SJ/T11363-2006 standard.

环境友好型产品。表示该产品的环保使用期限。某些零件会有一个不同的环保使用期限。
(绿色、电话单文标识) 贴在产品上。
此环保使用期限适用于产品及其产品手册中所规定的条件下工作。
The Environment-Friendly Use Period (EFUP) for all enclosed products and their parts are per the symbol shown here. The Environment-Friendly Use Period is valid only when the product is operated under the conditions defined in the product manual.

Safety and Regulatory Compliance

Dell provides a multi-language document that contains country-specific restrictions and additional safety and regulatory information for all Dell hardware products. The *Dell Networking W-Series Safety, Environmental, and Regulatory Information* document is included with this product.

Regulatory Model Names

The following regulatory model names apply to the W-IAP110 Series Instant access points:

- W-IAP114: APIN0114
- W-IAP115: APIN0115

FCC

The device is electronically labeled and the FCC ID is displayed via the WebUI under the **About** menu.

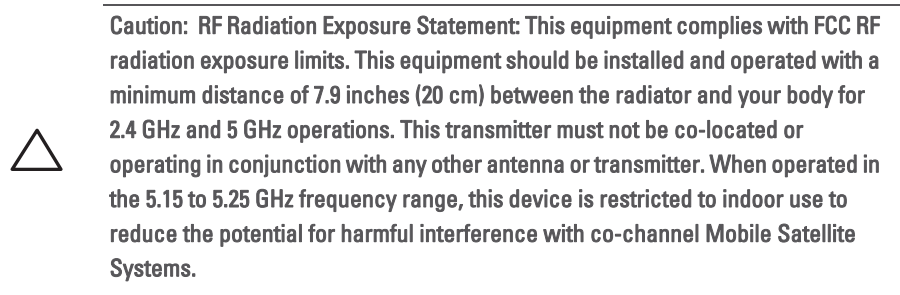

FCC Class B Part 15

This device complies with Part 15 of the Federal Communications Commission (FCC) Rules. Operation is subject to the following two conditions:

- This device may not cause harmful interference.
- This device must accept any interference received, including interference that may cause undesired operation.

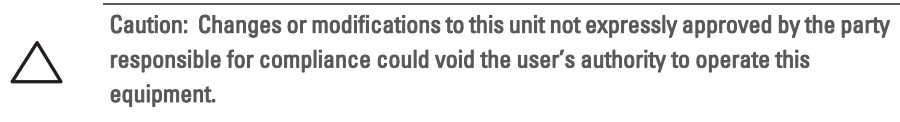

This equipment has been tested and found to comply with the limits for a Class B digital device, pursuant to Part 15 of the FCC Rules. This equipment generates, uses and can radiate radio frequency energy and, if not installed and used in accordance with the manufacturer's instructions, may cause interference harmful to radio communications.

If this equipment does cause interference, which can be determined by turning the equipment off and on, the user is encouraged to try to correct the interference by one or more of the following measures:

- Reorient or relocate the receiving antenna.
- Increase the separation between the equipment and receiver.
- Connect the equipment to an outlet on a circuit different from that to which the receiver is connected.
- Consult the dealer or an experienced radio or TV technician for help.

Complies with the Class B limits for radio noise emissions as set out in the interference-causing equipment standard entitled "Digital Apparatus," ICES-003 of Industry Canada.

Cet appareil numérique de la classe B respecte toutes les exigences du Règlement sur le matériel brouilleur du Canada.

Users are advised that high power Radars are allocated as primary users of the bands 5250-5350 MHz and 5650-5850 MHz and these Radars could cause interference and/or damage to Licensed Exempt WLAN devices.



EU Regulatory Conformance

This product is CE marked according to the provisions of the R & TTE Directive (1999/5/EC) - CE(!). Aruba Networks Inc., hereby declares that the APIN0114 / APIN0115 device models are in compliance with the essential requirements and other relevant provisions of Directive 1999/5/EC -CE(!)

The Declaration of Conformity made under Directive 1999/5/EC is available for viewing at [dell.com](#)

Dell Networking W-IAP110 Series Instant Access Point Installation Guide



Contacting Dell

Website Support	
Main Website	dell.com
Support Website	dell.com/support
Documentation Website	dell.com/support/manuals

Copyright

© 2013 Aruba Networks, Inc. Aruba Networks trademarks include Airwave, Aruba Networks®, Aruba Wireless Networks®, the registered Aruba the Mobile Edge Company logo, and Aruba Mobility Management System®, Dell™, the DELL™ logo, and PowerConnect™ are trademarks of Dell Inc.

All rights reserved. Specifications in this manual are subject to change without notice.

Originated in the USA. All other trademarks are the property of their respective owners.

Open Source Code

Certain Aruba products include Open Source software code developed by third parties, including software code subject to the GNU General Public License (GPL), GNU Lesser General Public License (LGPL), or other Open Source Licenses. The Open Source code used can be found at this site:

http://www.arubanetworks.com/open_source

Includes software from Litech Systems Design. The IF-MAP client library copyright 2011 Infoblox, Inc. All rights reserved. This product includes software developed by Lars Fenneberg, et al.

Legal Notice

The use of Aruba Networks, Inc. switching platforms and software, by all individuals or corporations, to terminate other vendors' VPN client devices constitutes complete acceptance of liability by that individual or corporation for this action and indemnifies, in full, Aruba Networks, Inc. from any and all legal actions that might be taken against it with respect to infringement of copyright on behalf of those vendors.



[www.dell.com](#)